

Phase Control SCR, 25 A

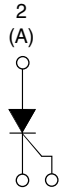

TO-220AB



1 (K) (G) 3

DESCRIPTION/FEATURES

The 25TTS.. High Voltage Series of silicon controlled rectifiers are specifically designed for medium power switching and phase control applications. The glass passivation technology used has reliable operation up to 125 °C junction temperature.



Available
RoHS*
COMPLIANT

Typical applications are in input rectification (soft start) and these products are designed to be used with Vishay HPP input diodes, switches and output rectifiers which are available in identical package outlines.

This product has been designed and qualified for industrial level and lead (Pb)-free ("PbF" suffix).

PRODUCT SUMMARY

V_T at 16 A	< 1.25 V
I_{TSM}	300 A
V_{RRM}	800/1200 V

OUTPUT CURRENT IN TYPICAL APPLICATIONS

APPLICATIONS	SINGLE-PHASE BRIDGE	THREE-PHASE BRIDGE	UNITS
Capacitive input filter $T_A = 55\text{ °C}$, $T_J = 125\text{ °C}$, common heatsink of 1 °C/W	18	22	A

MAJOR RATINGS AND CHARACTERISTICS

PARAMETER	TEST CONDITIONS	VALUES	UNITS
$I_{T(AV)}$	Sinusoidal waveform	16	A
I_{RMS}		25	
V_{RRM}/V_{DRM}		800/1200	V
I_{TSM}		300	A
V_T	16 A, $T_J = 25\text{ °C}$	1.25	V
dV/dt		500	V/ μ s
dl/dt		150	A/ μ s
T_J		- 40 to 125	°C

VOLTAGE RATINGS

PART NUMBER	V_{RRM} , MAXIMUM PEAK REVERSE VOLTAGE V	V_{DRM} , MAXIMUM PEAK DIRECT VOLTAGE V	I_{RRM}/I_{DRM} AT 125 °C mA
25TTS08PbF	800	800	10
25TTS12PbF	1200	1200	

* Pb containing terminations are not RoHS compliant, exemptions may apply

25TTS...PbF High Voltage Series



Vishay High Power Products Phase Control SCR, 25 A

ABSOLUTE MAXIMUM RATINGS						
PARAMETER	SYMBOL	TEST CONDITIONS	VALUES		UNITS	
			TYP.	MAX.		
Maximum average on-state current	$I_{T(AV)}$	$T_C = 93\text{ }^\circ\text{C}$, 180° conduction half sine wave	16		A	
Maximum RMS on-state current	I_{RMS}		25			
Maximum peak, one-cycle, non-repetitive surge current	I_{TSM}	10 ms sine pulse, rated V_{RRM} applied	300			
		10 ms sine pulse, no voltage reapplied	350			
Maximum I^2t for fusing	I^2t	10 ms sine pulse, rated V_{RRM} applied	450		A^2s	
		10 ms sine pulse, no voltage reapplied	630			
Maximum $I^2\sqrt{t}$ for fusing	$I^2\sqrt{t}$	$t = 0.1$ to 10 ms, no voltage reapplied	6300		$A^2\sqrt{s}$	
Maximum on-state voltage drop	V_{TM}	16 A, $T_J = 25\text{ }^\circ\text{C}$	1.25		V	
On-state slope resistance	r_t	$T_J = 125\text{ }^\circ\text{C}$	12.0		$m\Omega$	
Threshold voltage	$V_{T(TO)}$		1.0		V	
Maximum reverse and direct leakage current	I_{RM}/I_{DM}	$T_J = 25\text{ }^\circ\text{C}$	$V_R = \text{Rated } V_{RRM}/V_{DRM}$	0.5		mA
		$T_J = 125\text{ }^\circ\text{C}$		10		
Holding current	I_H	Anode supply = 6 V, resistive load, initial $I_T = 1$ A	-	100		
Maximum latching current	I_L	Anode supply = 6 V, resistive load	200			
Maximum rate of rise of off-state voltage	dV/dt		500		$V/\mu s$	
Maximum rate of rise of turned-on current	dI/dt		150		$A/\mu s$	

TRIGGERING				
PARAMETER	SYMBOL	TEST CONDITIONS	VALUES	UNITS
Maximum peak gate power	P_{GM}		8.0	W
Maximum average gate power	$P_{G(AV)}$		2.0	
Maximum peak positive gate current	$+I_{GM}$		1.5	A
Maximum peak negative gate voltage	$-V_{GM}$		10	V
Maximum required DC gate current to trigger	I_{GT}	Anode supply = 6 V, resistive load, $T_J = -10\text{ }^\circ\text{C}$	60	mA
		Anode supply = 6 V, resistive load, $T_J = 25\text{ }^\circ\text{C}$	45	
		Anode supply = 6 V, resistive load, $T_J = 125\text{ }^\circ\text{C}$	20	
Maximum required DC gate voltage to trigger	V_{GT}	Anode supply = 6 V, resistive load, $T_J = -10\text{ }^\circ\text{C}$	2.5	V
		Anode supply = 6 V, resistive load, $T_J = 25\text{ }^\circ\text{C}$	2.0	
		Anode supply = 6 V, resistive load, $T_J = 125\text{ }^\circ\text{C}$	1.0	
Maximum DC gate voltage not to trigger	V_{GD}	$T_J = 125\text{ }^\circ\text{C}$, $V_{DRM} = \text{Rated value}$	0.25	mA
Maximum DC gate current not to trigger	I_{GD}		2.0	

SWITCHING				
PARAMETER	SYMBOL	TEST CONDITIONS	VALUES	UNITS
Typical turn-on time	t_{gt}	$T_J = 25\text{ }^\circ\text{C}$	0.9	μs
Typical reverse recovery time	t_{rr}	$T_J = 125\text{ }^\circ\text{C}$	4	
Typical turn-off time	t_q		110	



25TTS...PbF High Voltage Series

Phase Control SCR, 25 A Vishay High Power Products

THERMAL AND MECHANICAL SPECIFICATIONS				
PARAMETER	SYMBOL	TEST CONDITIONS	VALUES	UNITS
Maximum junction and storage temperature range	T_J, T_{Stg}		- 40 to 125	°C
Maximum thermal resistance, junction to case	R_{thJC}	DC operation	1.1	°C/W
Maximum thermal resistance, junction to ambient	R_{thJA}		62	
Typical thermal resistance, case to heatsink	R_{thCS}	Mounting surface, smooth and greased	0.5	
Approximate weight			2	g
			0.07	oz.
Mounting torque	minimum		6 (5)	kgf · cm (lbf · in)
	maximum		12 (10)	
Marking device		Case style TO-220AB	25TTS08	
			25TTS12	

25TTS...PbF High Voltage Series



Vishay High Power Products Phase Control SCR, 25 A

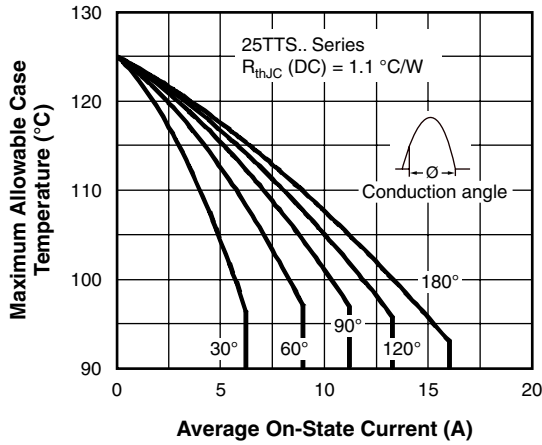

Fig. 1 - Current Rating Characteristics

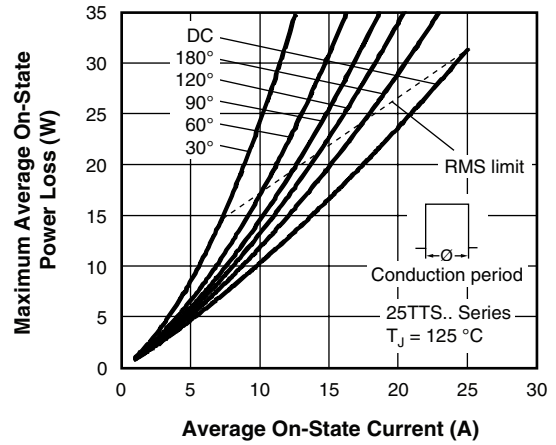

Fig. 4 - On-State Power Loss Characteristics

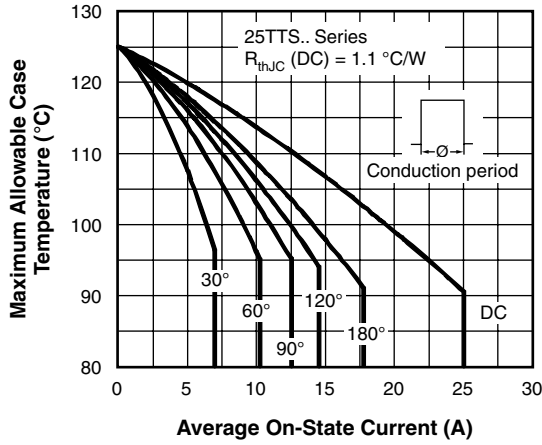

Fig. 2 - Current Rating Characteristics

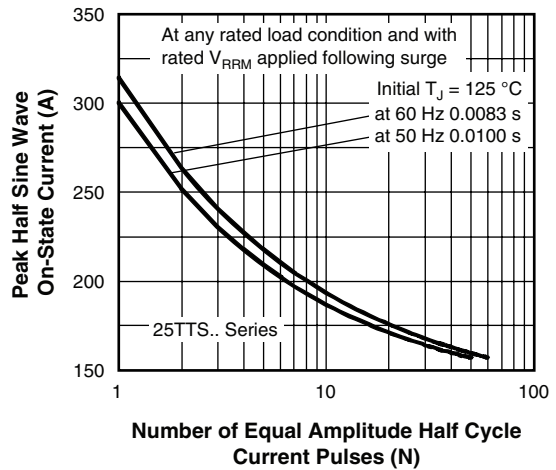

Fig. 5 - Maximum Non-Repetitive Surge Current

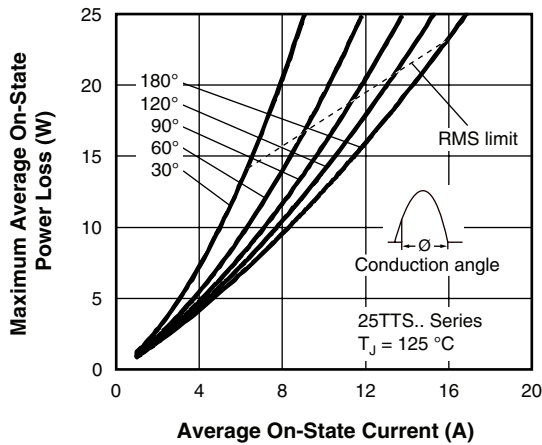

Fig. 3 - On-State Power Loss Characteristics

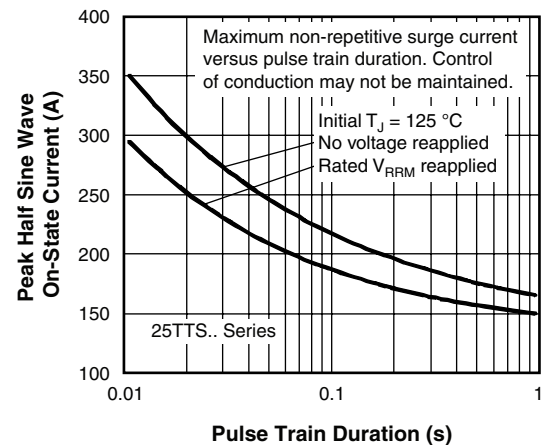

Fig. 6 - Maximum Non-Repetitive Surge Current



25TTS...PbF High Voltage Series

Phase Control SCR, 25 A Vishay High Power Products

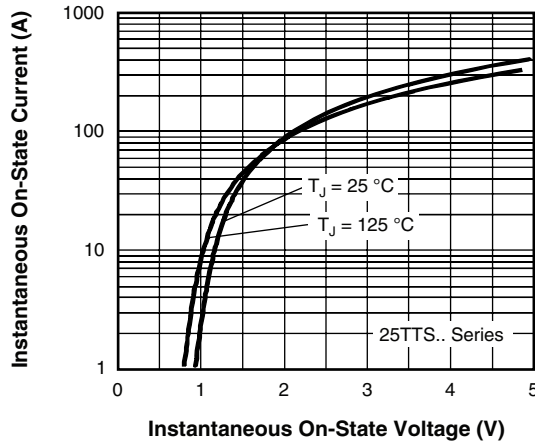

Fig. 7 - On-State Voltage Drop Characteristics

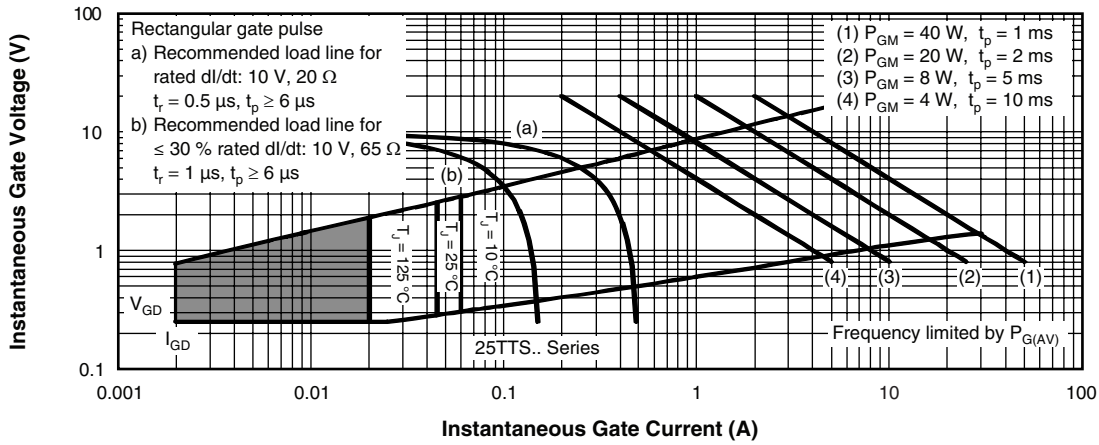

Fig. 8 - Gate Characteristics

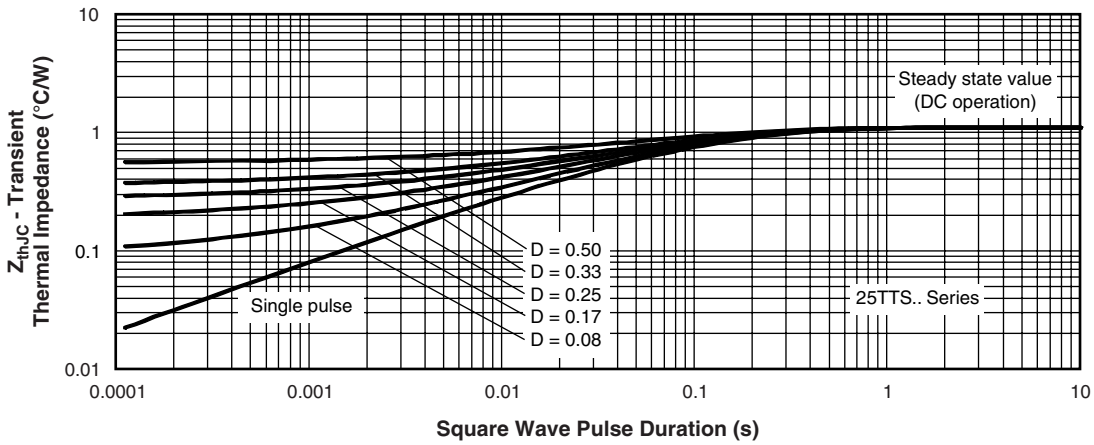

Fig. 9 - Thermal Impedance Z_{thJC} Characteristics

25TTS...PbF High Voltage Series

Vishay High Power Products Phase Control SCR, 25 A



ORDERING INFORMATION TABLE

Device code	25	T	T	S	12	PbF
	①	②	③	④	⑤	⑥
①	-	Current rating (25 = 25 A)				
②	-	Circuit configuration: T = Single thyristor				
③	-	Package: T = TO-220AB				
④	-	Type of silicon: S = Standard recovery rectifier				
⑤	-	Voltage rating				08 = 800 V 12 = 1200 V
⑥	-	• None = Standard production • PbF = Lead (Pb)-free				

LINKS TO RELATED DOCUMENTS	
Dimensions	http://www.vishay.com/doc?95222
Part marking information	http://www.vishay.com/doc?95225



Disclaimer

All product specifications and data are subject to change without notice.

Vishay Intertechnology, Inc., its affiliates, agents, and employees, and all persons acting on its or their behalf (collectively, "Vishay"), disclaim any and all liability for any errors, inaccuracies or incompleteness contained herein or in any other disclosure relating to any product.

Vishay disclaims any and all liability arising out of the use or application of any product described herein or of any information provided herein to the maximum extent permitted by law. The product specifications do not expand or otherwise modify Vishay's terms and conditions of purchase, including but not limited to the warranty expressed therein, which apply to these products.

No license, express or implied, by estoppel or otherwise, to any intellectual property rights is granted by this document or by any conduct of Vishay.

The products shown herein are not designed for use in medical, life-saving, or life-sustaining applications unless otherwise expressly indicated. Customers using or selling Vishay products not expressly indicated for use in such applications do so entirely at their own risk and agree to fully indemnify Vishay for any damages arising or resulting from such use or sale. Please contact authorized Vishay personnel to obtain written terms and conditions regarding products designed for such applications.

Product names and markings noted herein may be trademarks of their respective owners.